

Inclined pressure reducing valves

5330 series

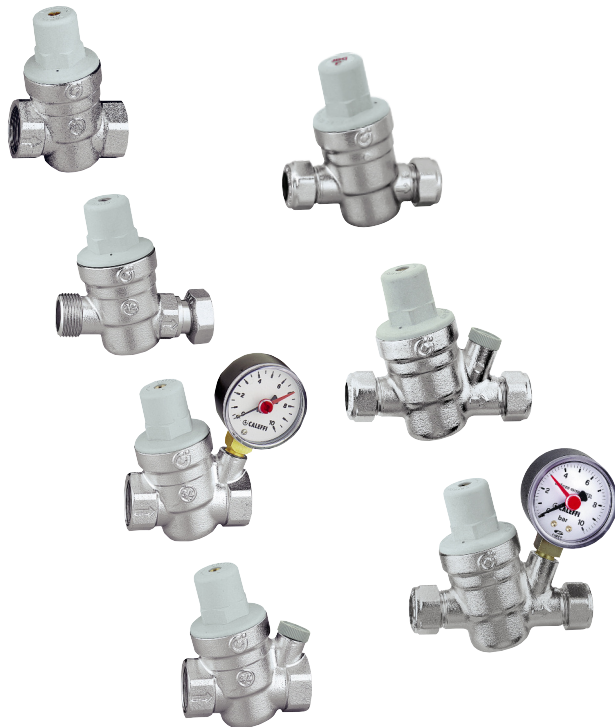

Function

Pressure reducing valves are installed in residential water system to reduce and stabilise inlet pressure from the water network which is generally too high and variable for domestic systems to work properly.

The 533. series was created for small systems, such as apartments, and to protect water storage heaters, where size and absence of noise are of particular concern.



Product range

5330 series	Inclined pressure reducing valve	_____	sizes DN 15 (1/2" F) and DN 20 (3/4" F)
5331 series	Inclined pressure reducing valve	_____	size DN 20 (3/4" M x 3/4" F with nut)
5332 series	Inclined pressure reducing valve with pressure gauge	_____	sizes DN 15 (1/2" F) and DN 20 (3/4" F)
5334 series	Inclined pressure reducing valve with pressure gauge connection	_____	sizes DN 15 (1/2" F), DN 20 (3/4" F) and DN 20 (1" F)
5336 series	Inclined pressure reducing valve	_____	sizes DN 15 (Ø 15) and DN 20 (Ø 22) for copper pipe
5337 series	Inclined pressure reducing valve with pressure gauge connection	_____	sizes DN 15 (Ø 15) and DN 20 (Ø 22) for copper pipe
5338 series	Inclined pressure reducing valve with pressure gauge	_____	sizes DN 15 (Ø 15) and DN 20 (Ø 22) for copper pipe

Technical specifications

Materials

Body:
 - 5330/1/2/4 series; brass EN 12165 CW617N, chrome plated
 - 5336/7/8 series; **CR** dezincification resistant alloy EN 12165 CW602N, chrome plated
 PA6G30
 Cover: **CR** dezincification resistant alloy EN 12164 CW724R
 Control stem: **CR** dezincification resistant alloy EN 12164 CW724R
 Cartridge: POM
 Internal components: **CR** dezincification resistant alloy EN 12164 CW724R
 Diaphragm: EPDM
 Seals: EPDM
 Strainer: stainless steel EN10088-2 (AISI 304)

Performance

Max. upstream pressure: 16 bar
 Downstream pressure setting range: 1–6 bar
 Factory setting: 3 bar
 Max. working temperature: 40°C
 Pressure gauge scale: 0–10 bar
 Medium: water

Connections

Main connections: see product range
 Pressure gauge connection: 1/4" F (ISO 228-1)

Dimensions

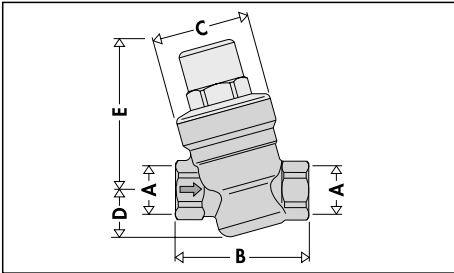

Code	DN	A	B	C	D	E	Mass (kg)
533041	15	1/2"	64	∅ 46	22,5	72,5	0,39
533051	20	3/4"	66	∅ 46	22,5	72,5	0,41

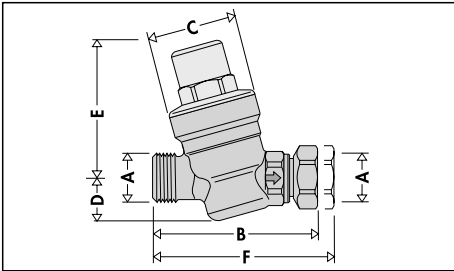

Code	DN	A	B	C	D	E	F	Mass (kg)
533151	20	3/4"	85,5	∅ 46	22,5	72,5	92	0,46

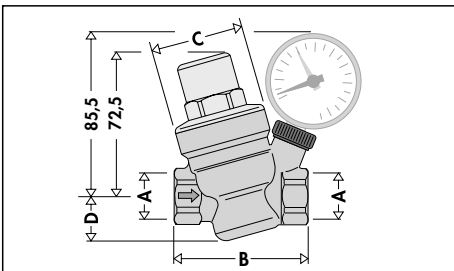

Code	DN	A	B	C	D	Mass (kg)
533241-533441	15	1/2"	70	∅ 46	22,5	0,51
533251-533451	20	3/4"	72	∅ 46	22,5	0,52
533461	20	1"	87	∅ 46	22,5	0,54

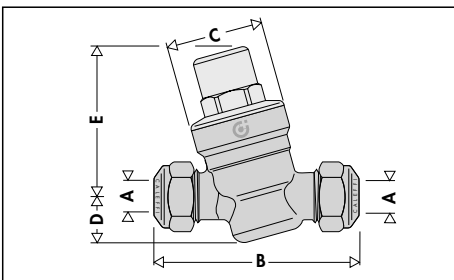

Code	DN	A	B	C	D	E	Mass (kg)
533641	15	∅ 15	91	∅ 46	22,5	72,5	0,43
533651	20	∅ 22	93	∅ 46	22,5	72,5	0,46

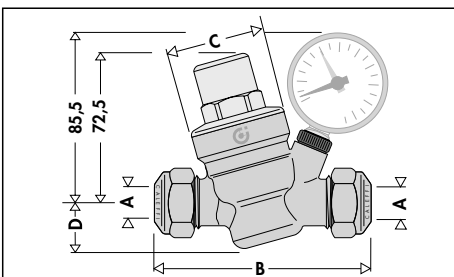

Code	DN	A	B	C	D	Mass (kg)
533741-533841	15	∅ 15	103	∅ 46	22,5	0,55
533751-533851	20	∅ 22	107	∅ 46	22,5	0,57

Operating principle

The functioning of the pressure reducing valve is based on the balance between two opposing forces:

- 1 the thrust of the **spring** to **open** the flow through the cross section.
- 2 the thrust of the **diaphragm** to **close** the flow through the cross section.

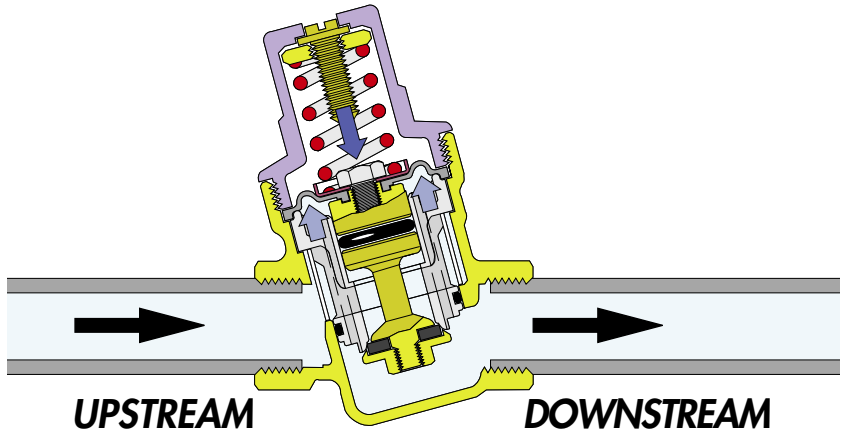

Operation with water flow

When a draw-off outlet is opened on the water system, the force of the spring becomes greater than that of the diaphragm; the obturator moves downwards opening the valve to the flow of water.

The greater the demand for water the lower the pressure under the diaphragm with a resulting greater flow of water through the valve.

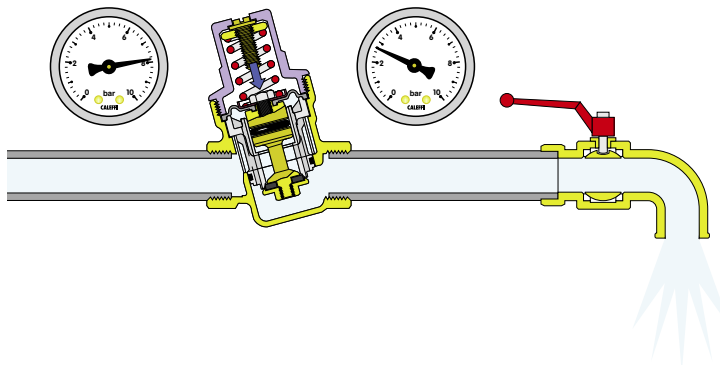

Operation without water flow

When the draw-off outlet is closed, the downstream pressure rises and pushes the diaphragm upwards.

As a result the obturator closes the valve to the passage of water and maintains the pressure constant at the calibrated pressure.

The slightest difference in favour of the force exercised by the diaphragm, in relation to that of the spring, causes the device to close.

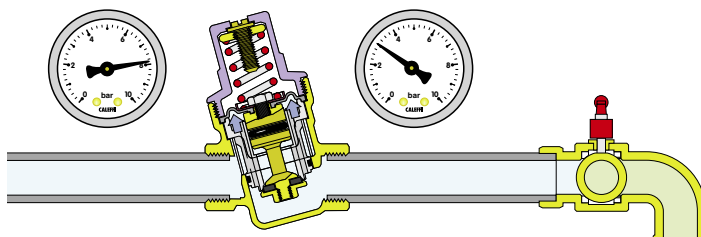

Construction details

Contoured diaphragm

The membrane was designed with a special shape to give an accurate pressure regulation as a function of changes in the downstream pressure.

This design feature also extends the valve life because the diaphragm is more resistant to pressure sudden changes and to wear.

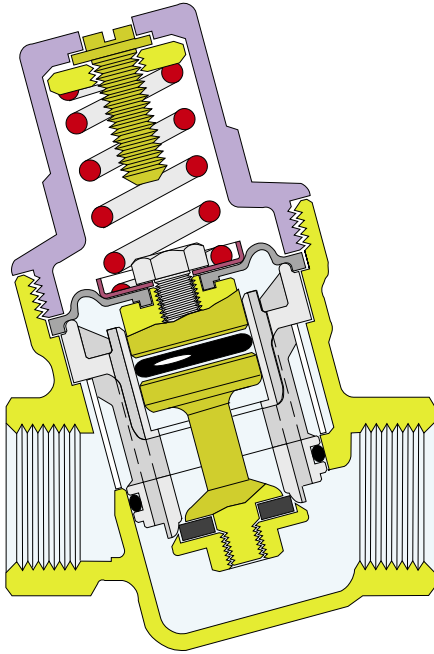

Silent operation

The large chamber on the outlet side of the reducing valve creates a low flow speed zone. This is particularly effective in reducing noise generated by narrowing the width of the passage through which the water flows when the valve is reducing pressure.

Small size

The "inclined" design makes the 533. series reducers small in size so that they are easy to fit especially in domestic systems.

Non-stick materials

The central support ❶, which contains the moving parts, is made of a plastic material with a low coefficient of adhesion. This reduces the probability of scale deposits being formed, the main cause of malfunction.

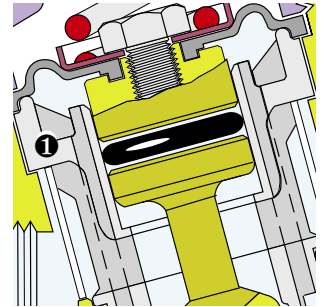

Extractable cartridge

The cartridges in the Caleffi 533. series pressure reducing valves can be removed for periodic cleaning and maintenance.

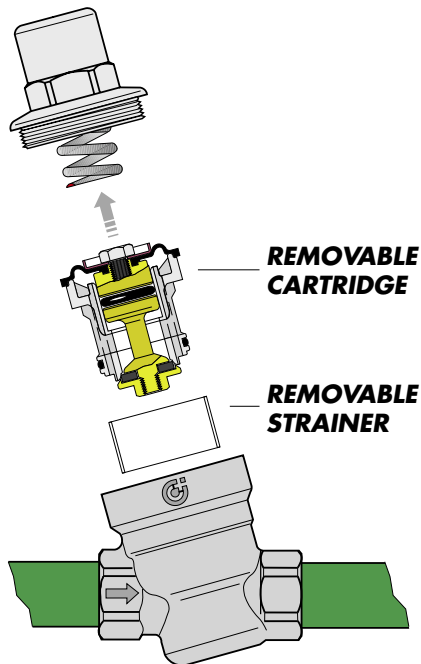

Use with boiler hydraulic safety groups

The 5331 model is specially designed for use with the Caleffi hydraulic safety groups for hot water storage heaters 5261 series. The 3/4" nut provided can be used for an easy direct connection upstream of the hydraulic safety groups.

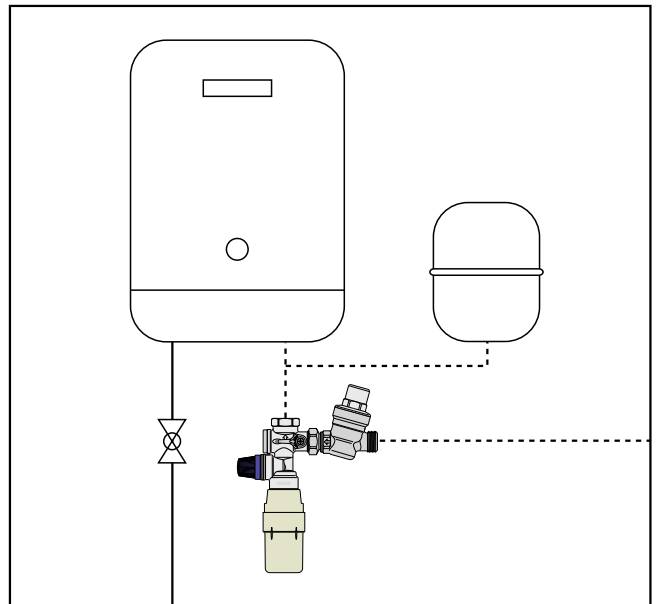

Approvals

The pressure reducing valves are approved as compliant with WRAS specifications in the United Kingdom and ACS in France.

Hydraulic characteristics

Diagram 1 (circulation velocity)

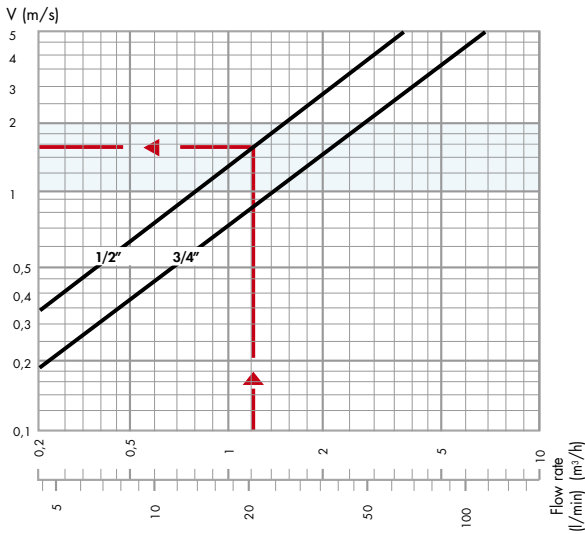
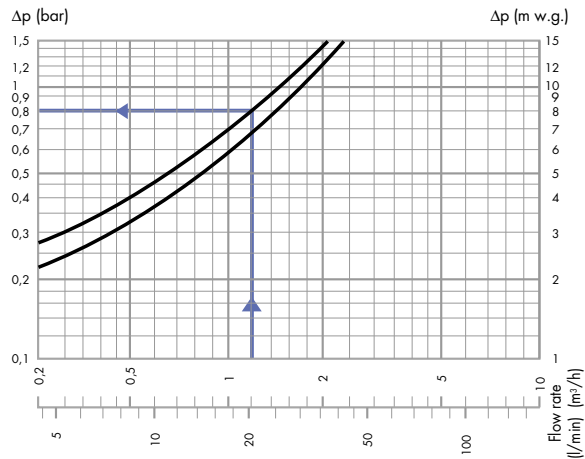

Diagram 2 (Pressure drop)



Reference values: Upstream pressure = 6 bar
Downstream pressure = 4 bar

Sizing the valve

The flow rates of commonly used appliances in domestic plumbing systems are given below to assist in the selection of the correct valve diameter:

Table of typical flow rates

Bathtub, kitchen sink, dishwasher	12 l/min
Shower	9 l/min
Washbasin, bidet, washing machine, WC with cistern	6 l/min

The simultaneous-use factor must be taken into account to avoid selecting a valve that is too large. Basically, the higher people quantity using the system, the lower the probability of two appliances being used at the same time.

Table of simultaneous-use factor values (%)

Number of appliances	Residential %	Community %	Number of appliances	Residential %	Community %	Number of appliances	Residential %	Community %
5	54	64,5	35	23,2	30	80	16,5	22
10	41	49,5	40	21,5	28	90	16	21,5
15	35,3	43,5	45	20,5	27	100	15,5	20,5
20	29	37	50	19,5	26	150	14	18,5
25	27,5	34,5	60	18	24	200	13	17,5
30	24,5	32	70	17	23	300	12,5	16,5

The steps to take for selecting the correct size are as follows:

- The total flow rate is calculated from the number and type of appliances present by taking the sum of the individual flow rates.

Example:

One living unit with 1 bathroom
 1 bidet $G = 6$ l/min
 1 shower $G = 9$ l/min
 1 wash basin $G = 6$ l/min
 1 wc with cistern $G = 6$ l/min
 1 kitchen sink $G = 12$ l/min
 1 washing machine $G = 12$ l/min

$G_{tot} = 51$ l/min
 No appliances = 6

- The design flow rate is calculated from the table of coefficients of simultaneity (using that for 10 appliances).

Example:

$G_{ds} = G_{tot} \cdot \% = 51 \cdot 41 \% = 21$ l/min

It is recommended that flow velocity is kept within 1 to 2 metres per second when calculating the correct reducing valve size. This will prevent noise in the pipes and rapid wear of appliances.

- The correct diameter of the reducing valve is taken from diagram 1 on the basis of the design flow rate taking into account an ideal flow velocity of between 1 and 2 m/s (blue band).

Example:

for $G_{ds} = 21$ l/min select diameter 1/2"
 (see indications on diagram 1)

- The pressure drop is taken from diagram 2, again on the basis of where the design flow rate intersects the curve for the relative diameter already selected (the downstream pressure falls by an amount equal to the pressure drop, with respect to the set pressure at no flow condition).

Example:

for $G_{ds} = 21$ l/min $1/2'' \Delta p = 0,8$ bar
 (see indications on diagram 2)

Recommended flow rates

For an average flow velocity of 1,5 m/s, the recommended flow rates for each diameter are as follows:

Diameter	1/2"	Ø 15	3/4"	Ø 22	1"
Flow rate m ³ /h	1,2	1,2	2,1	2,1	2,1
Flow rate l/min	20	20	35	35	35



Sizing software is available on
www.caleffi.com
 Apple Store and Google play.

Installation

1. Turn all taps on before installing the valve to flush the system and expel any air remaining in the pipes.
2. Install shut-off valves upstream and downstream of the pressure reducing valve to facilitate future maintenance operations.
3. The pressure reducing valve can be installed both on vertical and horizontal pipes. The upside-down installation is forbidden.
4. **Close downstream shut-off valve.**

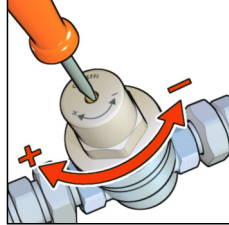

5. Set the device by turning the spring locking nut under the bell cap with a 10 mm hex key or flat-blade screwdriver clockwise to increase the setting or anticlockwise to reduce it.

6. Adjust until the correct pressure is read on the pressure gauge. The 533. series reducing valve are factory set at 3 bar.

Recommendations for installation

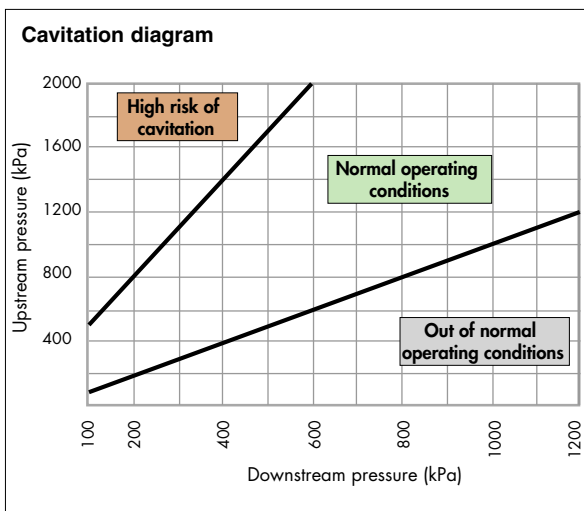

In order to minimise the risk of cavitation in the reducing valve, which could cause malfunctions with the risk of erosion in the seal area, vibration and noise, you are strongly advised to refer to the operating conditions specified in the diagram.

Due to numerous factors and variable conditions, such as: system pressure, temperature, presence of air, flow rate and speed, which could affect the performance of the pressure reducing valve; it is advisable to keep the ratio between upstream and downstream pressure ideally at 2:1 and no more than 3:1 (for example, upstream pressure 10 bar, downstream pressure 5 bar, pressure ratio = $10/5 = 2:1$) In these conditions, the risk of cavitation is minimised, but this does not preclude the possible effects of the many other factors in play in the system during operation. If the pressure ratio exceeds the specified limit, you should consider the design pressure of the system or the use of a first stage pressure reducing valve (e.g. first stage pressure reducing valve from 16 to 8 bar and second stage from 8 to 4 bar).

The upstream and downstream pipes of the pressure reducing valve must be secured with brackets in accordance with the manufacturer's instructions and local requirements, in order to avoid generating and transmitting noise and/or vibration in the installation.

1. Installation below ground

Installing pressure reducing valves below ground is not recommended, for four reasons:

- there is a risk of the reducing valve being damaged by frost
- inspection and maintenance is difficult
- reading the pressure gauge is difficult
- impurities may enter the device through the holes designed for the release of the volumetric compression present in the casing.

2. Water hammer

This is one of the main causes of damage in pressure reducing valves. It is best to fit special devices to absorb water hammer when installing pressure reducers in at-risk systems.

Trouble-shooting

Certain types of fault, which are generally due to faulty design of the system, are often wrongly attributed to pressure reducing valves. The most frequent cases are as follows:

1. Increased downstream pressure in the presence of a water heater

This problem is due to heating of the water caused by the water heater. There is not relief of the pressure because the reducing valve is rightly closed. The solution is to install an expansion vessel (between the heater and the reducing valve) to "absorb" the pressure increase.

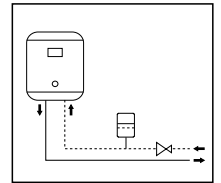

2. The reducing valve does not maintain its calibrated value

In most cases this is the result of impurities that deposit on the valve seat causing leakage with a resulting increase in pressure downstream. The solution is to fit a strainer upstream of the reducer and subsequently to maintain and clean the extractable cartridge (see *Maintenance*).

Maintenance

Proceed as follows for periodic cleaning of the strainer and inspection or replacement of the cartridge:

- 1 Shut off the reducing valve
- 2 Unscrew (anticlockwise) the calibrating screw to decompress the spring inside.
- 3 Unscrew the cover.
- 4 Extract the cartridge with the aid of pliers on the hexagonal part.
- 5 The cartridge can be fitted back into the valve after inspection and cleaning or alternatively a replacement cartridge can be fitted.
- 6 Recalibrate the reducing valve.

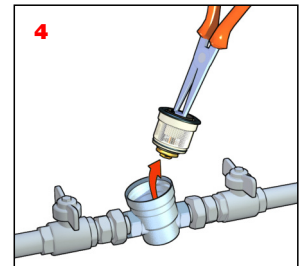
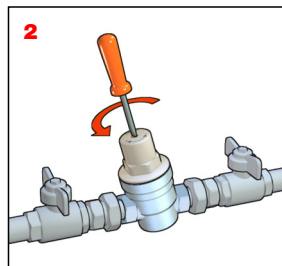

Application diagrams

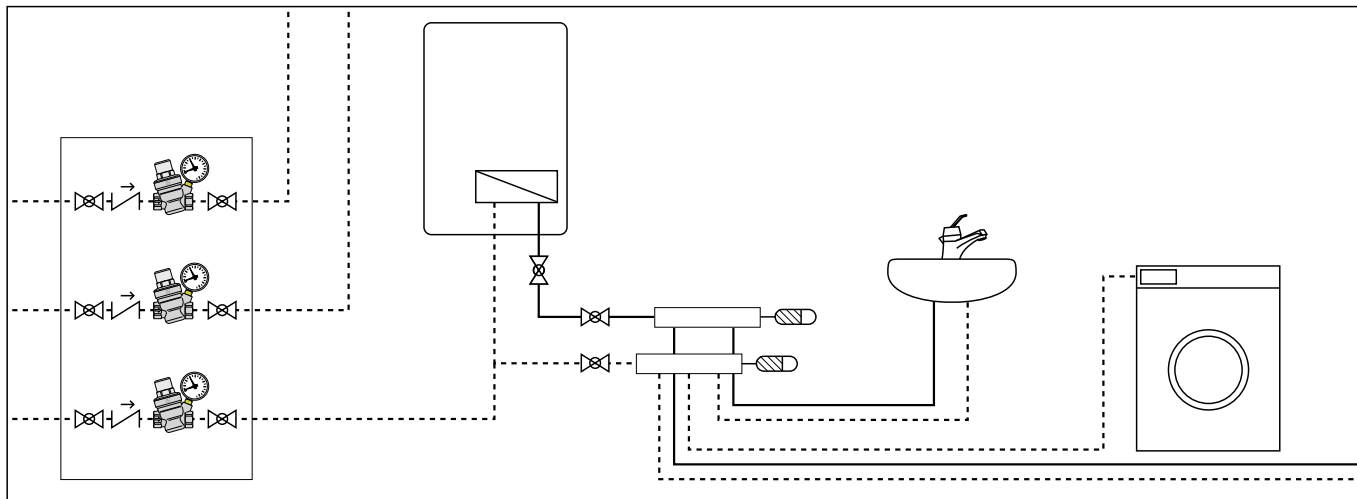

SPECIFICATION SUMMARY

5330 series

Inclined pressure reducing valve. Threaded connections 1/2" F (or 3/4" F). Size DN 15 (DN 15 and DN 20). Brass body. Chrome plated. Dezincification resistant alloy stem. Glass/nylon cover. EPDM diaphragm and seals. Maximum working temperature 40°C. Maximum upstream pressure 16 bar. Downstream pressure setting range from 1 to 6 bar. Extractable cartridge and strainer for maintenance operations.

5331 series

Inclined pressure reducing valve. Threaded connection 3/4" M x 3/4" F with nut. Size DN 15. Brass body. Chrome plated. Dezincification resistant alloy stem. Glass/nylon cover. EPDM diaphragm and seals. Maximum working temperature 40°C. Maximum upstream pressure 16 bar. Downstream pressure setting range from 1 to 6 bar. Extractable cartridge and strainer for maintenance operations.

5332 series

Inclined pressure reducing valve with pressure gauge. Threaded connections 1/2" F (or 3/4" F). Size DN 15 (DN 15 and DN 20). Pressure gauge connection 1/4" F. Brass body. Chrome plated. Dezincification resistant alloy stem. Glass/nylon cover. EPDM diaphragm and seals. Maximum working temperature 40°C. Maximum upstream pressure 16 bar. Downstream pressure setting range from 1 to 6 bar. Extractable cartridge and strainer for maintenance operations. Complete with pressure gauge, scale 0–10 bar.

5334 series

Inclined pressure reducing valve with pressure gauge connection. Threaded connections 1/2" F (from 1/2" to 1" F). Size DN 15 (DN 15 and DN 20). Pressure gauge connection 1/4" F. Brass body. Chrome plated. Dezincification resistant alloy stem. Glass/nylon cover. EPDM diaphragm and seals. Maximum working temperature 40°C. Maximum upstream pressure 16 bar. Downstream pressure setting range from 1 to 6 bar. Extractable cartridge and strainer for maintenance operations.

5336 series

Inclined pressure reducing valve. Ø 15 (or Ø 22) connections. Size DN 15 (DN 15 and DN 20). Dezincification resistant alloy body and stem. Chrome plated. Glass/nylon cover. EPDM diaphragm and seals. Maximum upstream temperature 40°C. Maximum working pressure 16 bar. Downstream pressure setting range from 1 to 6 bar. Extractable cartridge and strainer for maintenance operations.

5337 series

Inclined pressure reducing valve with pressure gauge connection. Ø 15 (or Ø 22) connections. Size DN 15 (DN 15 and DN 20). Pressure gauge connection 1/4" F. Dezincification resistant alloy body and stem. Chrome plated. Glass/nylon cover. EPDM diaphragm and seals. Maximum working temperature 40°C. Maximum upstream pressure 16 bar. Downstream pressure setting range from 1 to 6 bar. Extractable cartridge and strainer for maintenance operations.

5338 series

Inclined pressure reducing valve with pressure gauge. Ø 15 (or Ø 22) connections. Size DN 15 (DN 15 and DN 20). Pressure gauge connection 1/4" F. Dezincification resistant alloy body and stem. Chrome plated. Glass/nylon cover. EPDM diaphragm and seals. Maximum working temperature 40°C. Maximum upstream pressure 16 bar. Downstream pressure setting range from 1 to 6 bar. Extractable cartridge and strainer for maintenance operations. Complete with pressure gauge, scale 0–10 bar.

We reserve the right to make changes and improvements to the products and related data in this publication, at any time and without prior notice.